



# TIGER WINDOW FASHIONS

## Soft Lift™ Tension Adjustments - Open Roll

Instructions for Adjusting Spring Tension on Soft Lift™ Equipped Shades.

### Before Adjusting the tension.

The tension of the shade has been set at the factory.

To maintain this tension, your shade ships from the factory with the tension device locked inside the shade roll.

This procedure should only be performed by installation professionals.

Only perform this procedure if there is a problem with the factory setting.

### Determining Proper Spring Tension

The amount of tension needed for proper operation of the Soft Lift™ shade will vary for each installation depending on shade width, length and fabric weight.

### When to Add Spring Tension

If there is not enough tension, you may not be able to fully raise the shade or the shade will "slip" and will not hold its position at rest.

### Step 1 - Remove Shade Roll

**IMPORTANT! DO NOT LET GO OF THE TENSION DEVICE.**

**1A:** If not already lowered, lower shade to its fully drawn position.

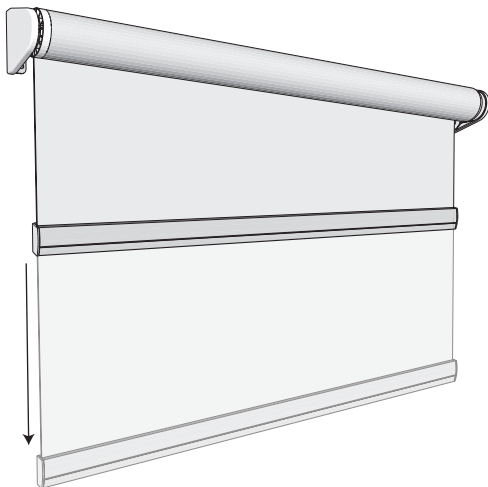

**1B:** With one hand hold the shade roll and the other hand firmly holding the tensioner device, carefully push the tensioner upwards on the bracket (1) then push the entire shade roll to the right (2) (or left depending on your installation configuration) until you can cleanly remove the shade roll from the shade roll hanging bracket.

**IMPORTANT! DO NOT LET GO OF THE TENSION DEVICE.**

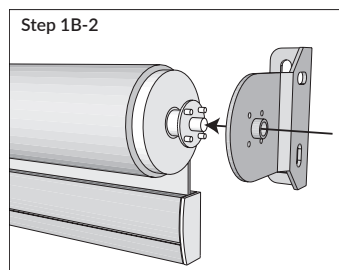
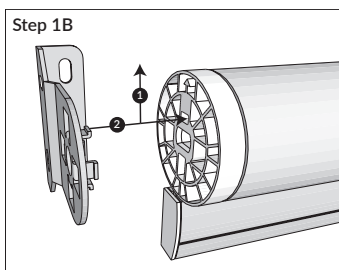

### Step 2 - Adjust Tension

**IMPORTANT! DO NOT LET GO OF THE TENSION DEVICE.**

**Increasing Tension:**

While firmly holding the tension device in place, slowly rotate the shade roll towards you (clockwise) one full rotation. Replace the shade into the shade roll brackets (Step 3) and test shade operation. Repeat as needed until desired tension is acquired.

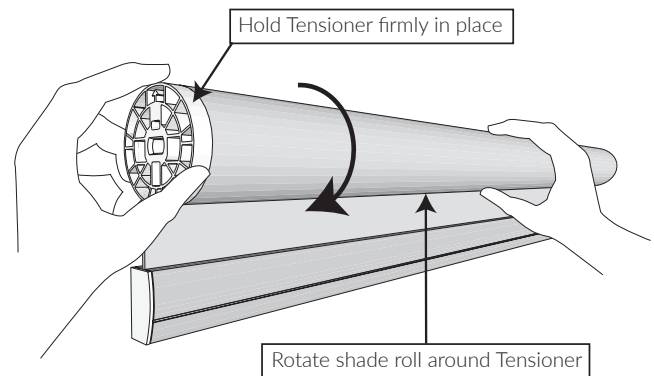

### Step 3 - Reinsert the Shade Roll

**Step 3A:** While firmly holding the tension device and shade roll, align the center and the 4 small pins of the spring loaded pin end of the shade roll and insert into the holes of the shade roll hanging bracket.

**Step 3B:** With the arrow of the tensioner (A) pointing upward, push the pin end towards its bracket, depressing the pin (1), then align and insert the hooks of the left bracket into the tensioner device (2). Gently pull down on the shade until the hooks have locked securely to the tensioner (3).

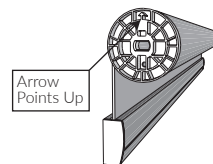

### Important!

When Re-installing the shade roll make sure the arrow on the tensioner is pointing up to properly seat on bracket.

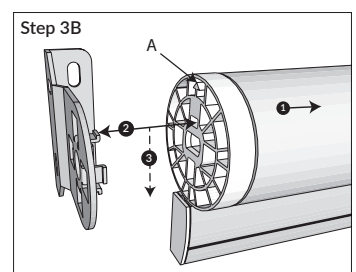
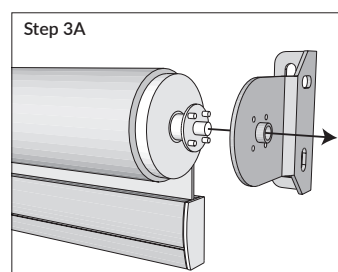

**NOTE:** Adding too much tension to the device may cause damage. Only add as much tension as is necessary to properly raise the shade.